

**New** XL7000U/XL7100U/WL7050U/WL7200U/UL7400U

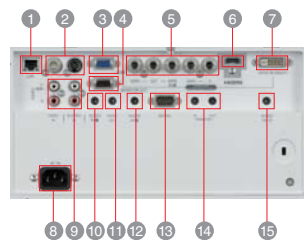

**Connection Terminals**

- 1 LAN (RJ-45)
- 2 Video / S-Video
- 3 PC/Component video in-1
- 4 Monitor out
- 5 PC/Component video in-2
- 6 HDMI
- 7 DVI-D in (HDCP)
- 8 Power in (3-pin with earth terminal)
- 9 Audio in [RCA (L/R)]
- 10 Audio in-1
- 11 Audio out
- 12 Audio in-2
- 13 Serial RS-232C (I/O)
- 14 Remote in/out
- 15 Audio DVI-D



**Dimensions (unit: mm)**

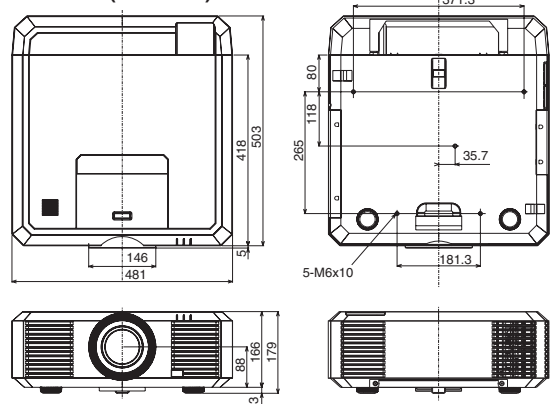

\* The lens focal point is the default set at the time of shipment from the factory.

**Options**

<p><b>OL-XL7100FR</b> Rear-projection Short-throw Fixed Lens (0.8)</p>	<p><b>OL-XL7100SZ</b> Short-throw Zoom Lens (1.2 - 1.5)</p>	<p><b>OL-XL7100LZ</b> Long-throw Zoom Lens (2.6 - 4.4)</p>	<p><b>OL-XL7100TZ</b> Telescopic-throw Zoom Lens (4.3 - 7.3)</p>
--	---	--	--



for a greener tomorrow

Eco Changes is the Mitsubishi Electric Group's environmental statement, and expresses the Group's stance on environmental management. Through a wide range of businesses, we are helping contribute to the realization of a sustainable society.

**Specifications**

Model	XL7000U	XL7100U	WL7050U	WL7200U	UL7400U
Display technology	0.8" 3-LCD (w/ Micro Lens)	0.75" 3-LCD (w/ Micro Lens)	0.76" 3-LCD (w/ Micro Lens)	0.76" 3-LCD (w/ Micro Lens)	0.76" 3-LCD (w/ Micro Lens)
Resolution	1024 x 768 (Total 786,432 pixels)	1280 x 800 (Total 1,024,000 pixels)	1280 x 800 (Total 1,024,000 pixels)	1920 x 1200 (Total 2,304,000 pixels)	1920 x 1200 (Total 2,304,000 pixels)
Brightness*1 (Iris off)	5200 lm	6000 lm	4700 lm	5500 lm	5000 lm
Contrast ratio*1	2000 : 1 (Iris on/off)				
Projection lens	f = 24.0-43.2mm, F = 1.8-2.6				
Zoom / focus	Powered focus / zoom (zoom ratio 1.8 : 1)				
Throw ratio	1.5 - 2.7	1.5 - 2.7	1.5 - 2.7	1.4 - 2.6	1.4 - 2.6
Picture size	40"-300" (100"=3.0m)	40"-300" (100"=3.1m)	40"-300" (100"=3.1m)	40"-300" (100"=3.1m)	40"-300" (100"=3.1m)
Estimated lamp life	Standard mode: 350W (Shut off time 3000 hrs) Low mode: 264W (Shut off time 4000 hrs)				
Computer compatibility	Resolution: 640 x 400 - 1920 x 1200 True: 1024 x 768, Sync-on-Green available	Resolution: 640 x 400 - 1920 x 1200 True: 1280 x 800, Sync-on-Green available	Resolution: 640 x 400 - 1920 x 1200 True: 1280 x 800, Sync-on-Green available	Resolution: 640 x 400 - 1920 x 1200 True: 1920 x 1200, Sync-on-Green available	Resolution: 640 x 400 - 1920 x 1200 True: 1920 x 1200, Sync-on-Green available
Video compatibility	NTSC / NTSC 4.43 / PAL (including PAL-M, N) / SECAM / PAL-60 Component video: 480i/p (525i/p), 576i/p (625i/p), 720p (750p 50/60Hz), 1080i (1125i 50/60Hz), 1080p (1125p 50/60Hz) SCART (RGB + 1V sync, only mini D-sub 15-pin Terminal)				
Input terminals	PC: 5 BNC x 1, mini D-sub 15-pin x 1, DVI-D (with HDCP) x 1, PC Audio: Stereo mini jack (ø3.5mm) x 3 Video: BNC x 1, S-Video (4-pin) x 1, HDMI (Ver 1.3, with Deep Color) x 1 (Only PCM audio is supported.), Audio: RCA (L/R) x 2				
Output terminals	RGB: mini D-sub 15-pin x 1 / Audio: Stereo mini jack (ø3.5mm) x 1 (Variable out)				
Communication terminals	LAN (RJ-45): x 1 (projector control), SERIAL (in): D-sub 9-pin (male) x 1 (direct command is available.), Wired remote (in): x 1 (ø3.5mm stereo mini jack), Wired remote (out): x 1 (ø3.5mm stereo mini jack),				
Speaker Output	10W Mono				
Dimensions (W x H x D)	18.9" x 6.8" x 16.5" (excluding detachable terminal cover and protrusion)				
Weight	23.2lbs (excluding detachable terminal cover)				
Power supply	AC 100 - 240V, 50/60Hz				
Included Accessories	AC Power Cable, RGB cable, RS-232C cable, Terminal-Cover, Remote Unit (incl. Battery), User Manual CD, Safety Manual				
Warranty	3-Years or 10,000 hours (whichever comes first) Limited P&L Warranty, Express Replacement Assistance (ERA) during the warranty period, 1-yr or 500hrs lamp warranty (whichever comes first)				

\*1) Compliant with ISO21118-2005.

\*Varies depending on condition.

\*Lamp life specification is an estimate based on verification under proper conditions and is not the duration of the warranty. Lamp will shut-off automatically when usage reaches the specified estimated maximum lamp hours. Service life may vary widely depending on usage and operating environment and conditions, as well as users' adherence to the maintenance and cleaning procedures provided in the user manual.

\*HDMI, the HDMI Logo, and High-Definition Multimedia Interface are trademarks or registered trademarks of HDMI Licensing LLC in the United States and other countries.

\*All brand names and product names are trademarks, registered trademarks or trade names of their respective holders.

**Screen Size and Projection Distance**

Refer to the following table to determine the screen size and projection distance.

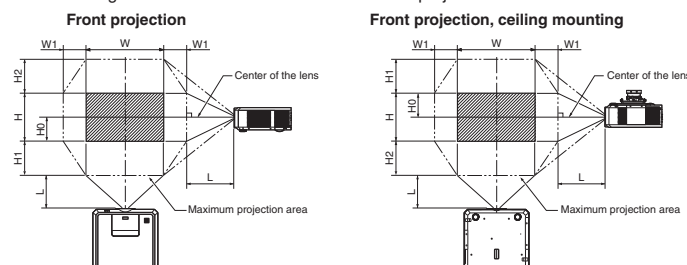

■ XL7000U / XL7100U

Screen (WXGA 4:3)			Distance from Screen		Default Height Projected Image (HO)		Movable V Position from Default Position			Movable H Position from Default Position									
Diagonal Size	Width	Height	Shortest (Wide)	Longest (Tall)	Down	Up	Down	Up	Left	Right	Left	Right							
40	102	32	81	24	61	46	1.2	85	2.1	-12	-30	14	-0 → +14	37	-0 → +37	10	-0 → +10	24	-0 → +24
60	152	48	122	36	91	70	1.8	128	3.2	-18	-46	22	-0 → +22	55	-0 → +55	14	-0 → +14	37	-0 → +37
80	203	64	163	48	122	94	2.4	171	4.3	-24	-61	29	-0 → +29	73	-0 → +73	19	-0 → +19	49	-0 → +49
100	254	80	203	60	152	118	3.0	214	5.4	-30	-76	36	-0 → +36	91	-0 → +91	24	-0 → +24	61	-0 → +61
150	381	120	305	90	229	177	4.5	322	8.2	-45	-114	54	-0 → +54	137	-0 → +137	36	-0 → +36	91	-0 → +91
200	508	160	406	120	305	237	6.0	430	10.9	-60	-152	72	-0 → +72	183	-0 → +183	48	-0 → +48	122	-0 → +122
250	635	200	508	150	381	297	7.5	538	13.7	-75	-191	90	-0 → +90	229	-0 → +229	60	-0 → +60	152	-0 → +152
300	762	240	610	180	457	357	9.1	646	16.4	-90	-229	108	-0 → +108	274	-0 → +274	72	-0 → +72	183	-0 → +183

■ WL7050U / WL7200U

Image (WXGA 16:10)			Distance from Screen		Default Height Projected Image (HO)		Movable V Position from Default Position			Movable H Position from Default Position									
Diagonal Size	Width	Height	Shortest (Wide)	Longest (Tall)	Down	Up	Down	Up	Left	Right	Left	Right							
40	102	34	66	21	54	48	1.2	89	2.3	-11	-27	15	-0 → +15	38	-0 → +38	10	-0 → +10	26	-0 → +26
60	152	51	129	32	81	73	1.9	134	3.4	-16	-40	22	-0 → +22	57	-0 → +57	15	-0 → +15	39	-0 → +39
80	203	68	172	42	108	99	2.5	180	4.6	-21	-54	30	-0 → +30	75	-0 → +75	20	-0 → +20	52	-0 → +52
100	254	85	215	53	135	124	3.1	225	5.7	-26	-67	37	-0 → +37	94	-0 → +94	25	-0 → +25	65	-0 → +65
150	381	127	323	79	202	187	4.7	338	8.6	-40	-101	56	-0 → +56	141	-0 → +141	38	-0 → +38	97	-0 → +97
200	508	170	431	106	269	249	6.3	462	11.5	-53	-135	74	-0 → +74	188	-0 → +188	51	-0 → +51	129	-0 → +129
250	635	212	538	132	337	312	7.9	565	14.4	-66	-168	93	-0 → +93	236	-0 → +236	64	-0 → +64	152	-0 → +152
300	762	254	646	159	404	375	9.5	679	17.2	-79	-202	111	-0 → +111	283	-0 → +283	76	-0 → +76	194	-0 → +194

■ UL7400U

Image (WUXGA 16:10)			Distance from Screen		Default Height Projected Image (HO)		Movable V Position from Default Position			Movable H Position from Default Position									
Diagonal Size	Width	Height	Shortest (Wide)	Longest (Tall)	Down	Up	Down	Up	Left	Right	Left	Right							
40	102	34	66	21	54	48	1.2	89	2.3	-11	-27	13	-0 → +13	32	-0 → +32	10	-0 → +10	26	-0 → +26
60	152	51	129	32	81	73	1.8	133	3.4	-16	-40	19	-0 → +19	48	-0 → +48	15	-0 → +15	39	-0 → +39
80	203	68	172	42	108	97	2.5	177	4.5	-21	-54	25	-0 → +25	65	-0 → +65	20	-0 → +20	52	-0 → +52
100	254	85	215	53	135	122	3.1	222	5.6	-26	-67	32	-0 → +32	81	-0 → +81	25	-0 → +25	65	-0 → +65
150	381	127	323	79	202	184	4.7	334	8.5	-40	-101	48	-0 → +48	121	-0 → +121	38	-0 → +38	97	-0 → +97
200	508	170	431	106	269	246	6.3	446	11.3	-53	-135	64	-0 → +64	162	-0 → +162	51	-0 → +51	129	-0 → +129
250	635	212	538	132	337	308	7.8	569	14.2	-66	-168	79	-0 → +79	202	-0 → +202	64	-0 → +64	152	-0 → +152
300	762	254	646	159	404	371	9.4	671	17.0	-79	-202	95	-0 → +95	242	-0 → +242	76	-0 → +76	194	-0 → +194

\* The above figures are approximate and may be slightly different from the actual measurements.



Changes for the Better

MULTIMEDIA DATA/VIDEO PROJECTORS



Striking Images, Simple to Use...  
From Installation to Operation –  
Amazingly High Quality in Every Aspect

New

XL7000U  
XL7100U  
WL7050U  
WL7200U  
UL7400U

MITSUBISHI ELECTRIC  
VISUAL SOLUTIONS AMERICA  
Professional Product Sales  
Phone: 888.307.0349  
www.mitsubishi-presentations.com

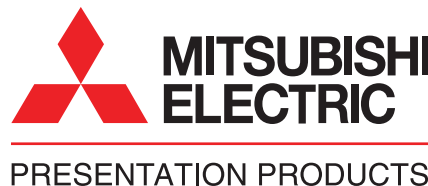

MITSUBISHI ELECTRIC SALES  
CANADA, INC.  
Display & Imaging Solutions Division  
Phone: 905.475.7728  
www.mitsubishielectric.ca

for a greener tomorrow



# Advanced, Multifunctional Projector – Ideal for large meeting rooms and theater-like settings

Mitsubishi Electric's 7000 series projectors offer high levels of brightness and contrast, improved installation ease and eco-conscious features in consideration of the environment. Capable of ensuring clear, sharp large-screen presentations in large meeting rooms and theater-like settings, these user-friendly projectors are ideal for impactful, visual communications.



**New** XL7000U/XL7100U/WL7050/WL7200U/UL7400U

## High Image Quality

### Impressive 6000lm\*1 Brightness and 2000:1\*2 High Contrast

The XL7100U reproduces vivid beautiful images using 6000lm\*1 brightness at a high contrast ratio of 2000:1\*2. Even in large meeting rooms and theater-like settings, its liquid-crystal projection system ensures clear, sharp presentation images every time.

\*1) WL7200U: 5500lm, UL7400U: 5000lm, XL7000U: 5200lm, WL7050: 4700lm \*2) At the iris on.

### High-performance Lens

This lens is comprised of 17 lenses in 13 clusters, including a high-performance ED (ultra-low dispersion) lens that is more efficient than regular glass lenses. Image resolution all the way to peripheral borders is greatly improved.

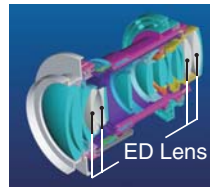

### Natural Color Matrix (NCM)

In addition to conventional red (R), green (G) and blue (B) color gradations, the intermediate colors of yellow (Y), magenta (M) and cyan (C) can each be controlled independently. Accentuating specified colors according to need results in the reproduction of vivid color tones one step closer to natural.

### Super Resolution

This innovative advanced image processing algorithm is a product of Mitsubishi Electric. The technology analyzes blurred components of the original images, estimates the high-resolution data not provided in the original signal and corrects the image quality. The result is the clear projection of images such as people's faces in fine detail.

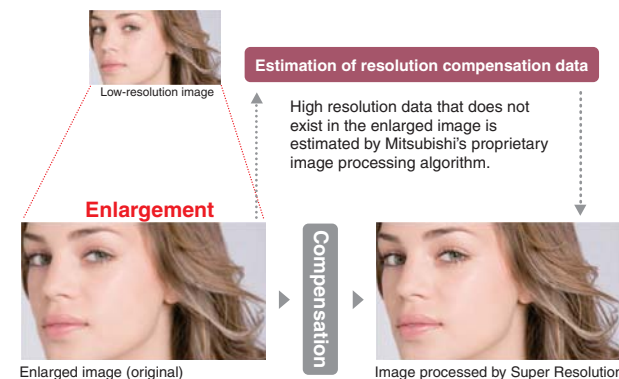

## Installation Flexibility

### Wide-area Lens Shift

The WL7050 & WL7200U features a wide-area lens adjustment range of  $\pm 70\%$  vertically and  $\pm 30\%$  horizontally, for greater installation freedom. The zoom, focus and lens shift functions are all powered operation.

\*XL7000U/XL7100U:  $\pm 60\%$  vertically,  $+30\%$  horizontally  
UL7400U:  $\pm 60\%$  vertically,  $\pm 30\%$  horizontally

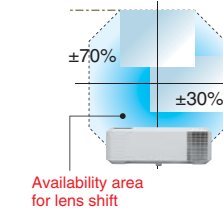

### Variety of Optional Lenses

Choose from four different lenses to best match the projection distance. Compared to previous lenses, each lens covers a wider range of projection ratios.

### Bayonet Mount

The bayonet mounting system incorporated offers one-touch lens removal, making it easy to change lenses after installation. Simply unscrew and remove the anti-drop cover, press down on the release button and turn the lens to remove it. Similarly, to install a lens, just insert it and turn.



### Attractive Design

In consideration of ceiling-mounted installation and appearance in terms of room décor, a modern center-lens, white-based design is adopted and a terminal cover that hides cables has been added. The remote-control signal receiving section is now located on the backside of the projector, improving remote-control operation performance when mounted on the ceiling.



### Geometric Corrections

• **Keystone Correction**  
Trapezoidal distortion caused when the projector is not positioned directly in front of the screen is corrected in both vertical and horizontal directions.

• **Cornerstone Correction**  
Pixel conversion is used to correct trapezoidal and diagonal distortion that causes oblique images, ensuring the proper aspect ratio.

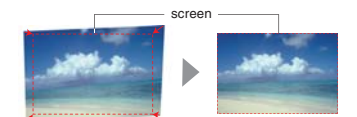

• **Curved-surface Projection Correction**

Projectors in the series are equipped with a distortion correction function that can be used when projecting images onto curved surfaces. Coordinates at the image's four corners are adjusted, enabling the projection angle to be adjusted at the time of angled or stacked projection. It is extremely handy for unique applications like projecting images onto special surfaces such as pillars at event sites.



### 360° Projection Capability

Images can be projected over a full 360° range along the vertical axis\* including reproduction on the ceiling or floor. The application possibilities are limitless.



\*Excluding use in high-altitude mode.

- ID-compatible Remote Control (set IDs for up to 63 projectors)
- Extended-distance Remote Control (wireless: 30m, wired: 100m)
- Lamp side replacement

## High Reliability

### Inorganic Liquid-crystal Panel

An inorganic liquid-crystal panel is incorporated, increasing the service life compared to that of conventional organic liquid-crystal panels.

### 4000hr Long-life Lamp\*

By optimizing temperature control design, the light-source lamp can be used for up to 4,000 hours. These improvements result in a remarkable reduction in operating cost.

\*When used in low mode.

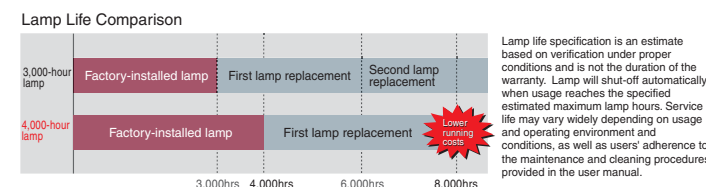

Lamp life specification is an estimate based on verification under proper conditions and is not the duration of the warranty. Lamp will shut-off automatically when usage reaches the specified estimated maximum lamp hours. Service life may vary widely depending on usage and operating environment and conditions, as well as users' adherence to the maintenance and cleaning procedures provided in the user manual.

### Roll-up Filter\*

To help prevent dust from collecting on the liquid-crystal panel, a cartridge-type filter is added as standard equipment. It can be set so that the filter rolls automatically every 500, 750 or 1,000 hours, or winding can be done manually.



\*Equipped on XL7100U, WL7200U, & UL7400U only

## Eco friendly

### 4000hr Long-life Lamp\*

A light-source lamp capable of operating up to 4,000 hours reduces both operating cost and labor required for replacing lamps.

\*When used in low mode.

### Stand-by Wattage under 0.3W\*

Stand-by (low) mode power consumption is less than 0.3W, offering increased energy savings and further contributing to environmental preservation.

\*When in stand-by (low) mode. At this time, use of the LAN function is not possible.

### Quiet 30dB\* Operation

Fan noise during projector operation can be distracting during a presentation or videoconference. The XL7000U, XL7100U, WL7050U, and WL7200U projectors operate at a significantly low noise level of only 30dB (i.e., in "low lamp" mode). As a result, presentations and conferences can be held without distracting projector noise in the background.

\*UL7400U: 32dB

### Auto Power Off

If no image signal is output for a predetermined period of time\*, power is automatically turned off, realizing energy savings by reducing needless power consumption.

\*Time preset by user

### Paint-free Cabinet

As a measure to help protect the environment, eco-conscious paint-free cabinets are incorporated for these 7000 Series projectors.

## Additional Features

### Network Connectivity

Projectors are equipped with a RJ-45 LAN terminal for remote operation. Additionally, when used with Crestron RoomView™, integrated control of up to 250 projectors including power on/off control, message display and confirmation of lamp service hours is possible. Mitsubishi Electric 7000 series are equipped with AMX Device Discovery for simplified device management and compatible with PJLink™.



The trademark of PJLink is trademark applied for registration or registered trademark in Japan, the United States, and other countries and areas.

- 2-Screen mode (PiP: XL7000U/XL7100U Split: WL7050U/WL7200U/UL7400U)
- Test pattern
- Direct power off
- Closed caption support
- High-altitude mode (1,500 to 2,700m)
- Virtual DICOM mode
- OSD menu multilanguage compatibility (20 languages\*)

\*Existing languages: Chinese, English, French, German, Italian, Japanese, Korean, Polish, Portuguese, Russian, Spanish, Swedish  
Languages added: Dutch, Indonesian, Malaysian, Norwegian, Thai, Turkish, Vietnamese, Arabic